











## 220x250 MAN-R

## 220x250 GH-R

	$\square 0^\circ$	$\nabla 45^\circ$	$\nabla 60^\circ$	$\sphericalangle 45^\circ$	$\sphericalangle 60^\circ$	$\frac{a}{b}$
	220	160	90	x	x	x
	120*	85*	55*	x	x	x
	230x190	160x90	90x90	x	x	230x120

				
3x400V	0,75/ 1,1	30/65	2450x27x0,9	260
L	B	Hmax	V	
1200	650	1800	925	

\*doporučené hodnoty/recommended values

220-M2V

220-MST

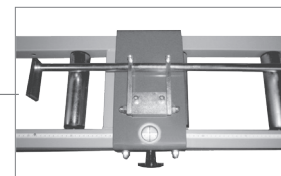
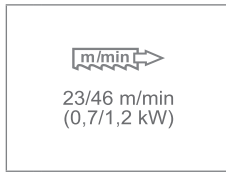
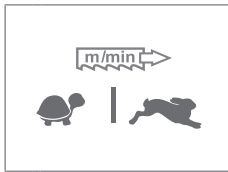

VD 3000/280

VD 2000/280

VDO 3000/280

VDO 2000/280

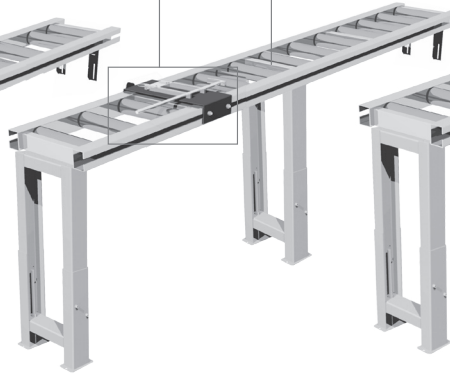

VDN 280



RD 1000/290

RD-VR-290  
+RD

OZ 1000  
OZ 2000  
OZ 3000  
OZ 4000  
OZ 5000  
OZ 6000

RB 200

RBS 200/290  
+RB

RHS 290  
+BRS +RB

220-RDZ

RDN

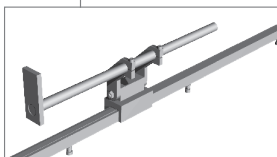

OZ 0000

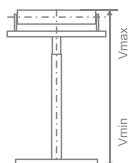
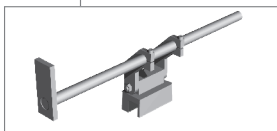

	S (mm)	Vmin (mm)	Vmax (mm)
<b>V280</b>	280	740	1100

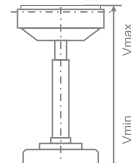

	S (mm)	Vmin (mm)	Vmax (mm)
<b>R290</b>	290	760	980

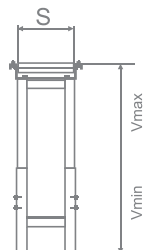
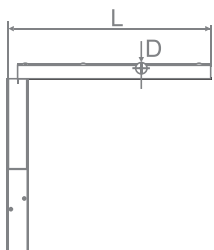

	S (mm)	L (mm)	Vmin (mm)	Vmax (mm)		
<b>VD</b>	280	2000	740	1100	9	100
		3000			13	
<b>VDO</b>	280	2000	740	1100	9	100
		3000			13	
<b>R</b>	290	1000	760	980	4	200
		2000			7	

## 220x250 MAN-R, 220x250 GH-R

STANDARD

OPTION



PEGAS-GONDA s.r.o., Čs.armády 322, 684 01 Slavkov u Brna, CZECH REPUBLIC  
Tel: 00420-544 221 125 (126), Fax: 00420-544 227 389, E-mail: pegas@gonda.cz  
www.pegas-gonda.cz

- výrobce si vyhrazuje právo provádět změny technických údajů, technické údaje odpovídají 1.5.2015  
/ producer has the right to make changes of technical data, technical data are valid on 1.5.2015 /  
- pila na fotografii není vždy v základním provedení, uvedené rozměry odpovídají stroji v základním provedení  
/ the machine in the picture is not always in the basic version, mentioned diameters are for machine in basic version /

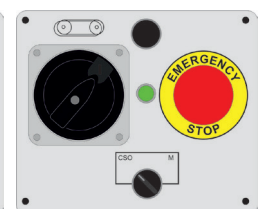
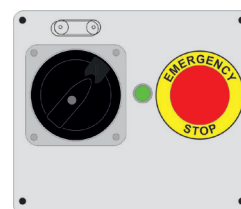

CONTROL PANEL: MAN

CONTROL PANEL: GH